

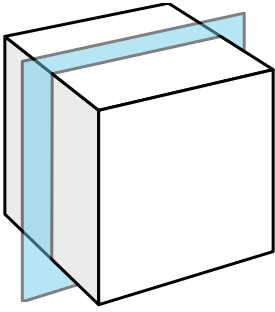

Xác định hình dạng 2d sẽ được tạo ra nếu hình dạng 3d được cắt như hình bên.

1)



2)

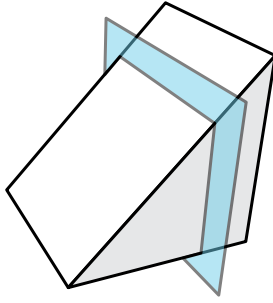

3)

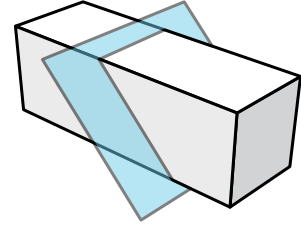

4)

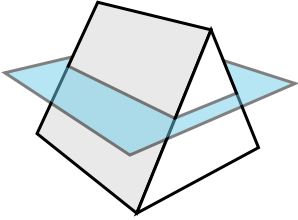

5)

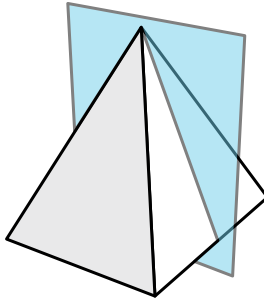

6)

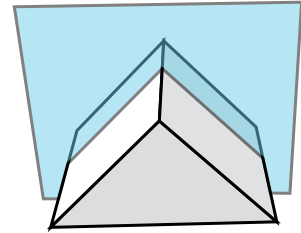

7)

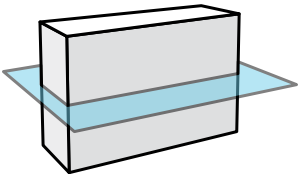

8)

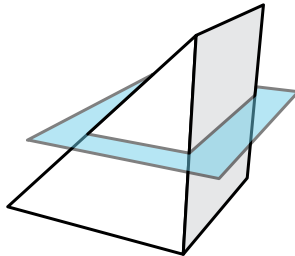

9)

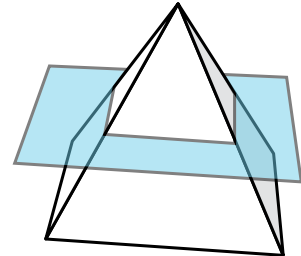



Xác định hình dạng 2d sẽ được tạo ra nếu hình dạng 3d được cắt như hình bên.

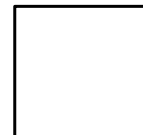
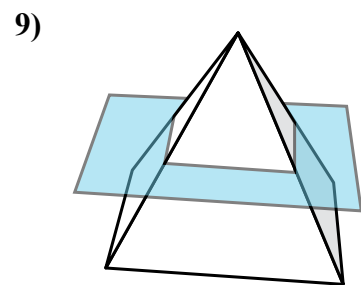
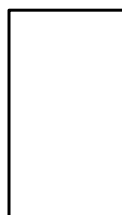
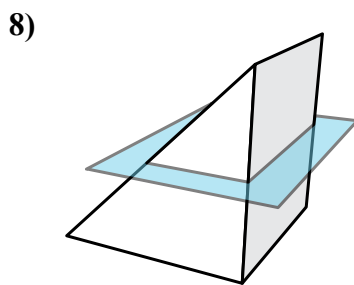
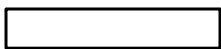
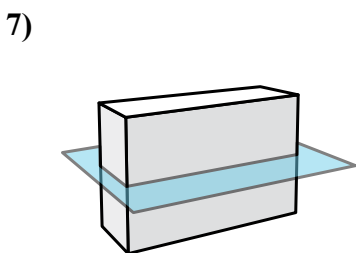
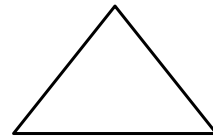
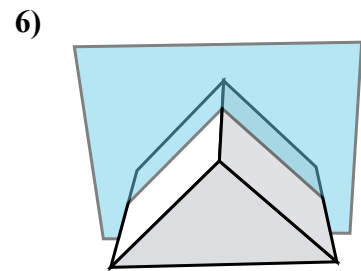
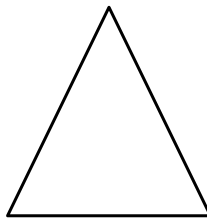
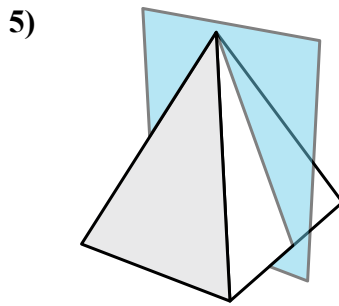
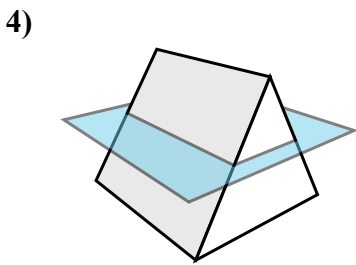
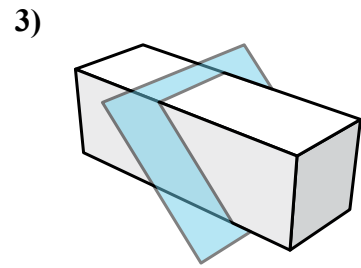
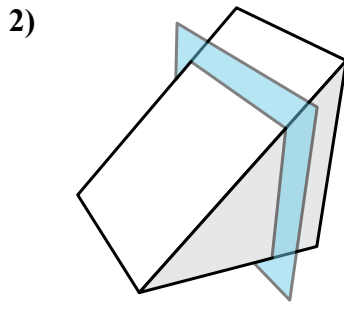
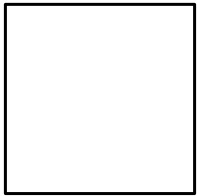
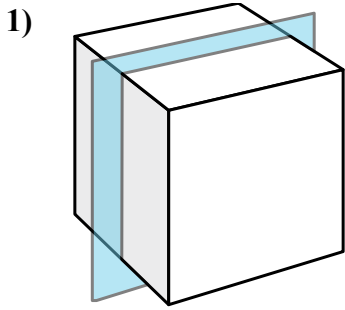



Xác định hình dạng 2d sẽ được tạo ra nếu hình dạng 3d được cắt như hình bên.

1)

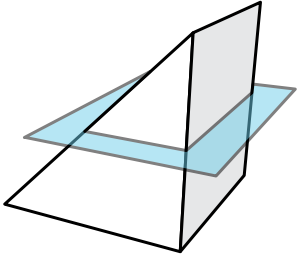

2)

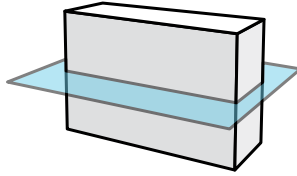

3)

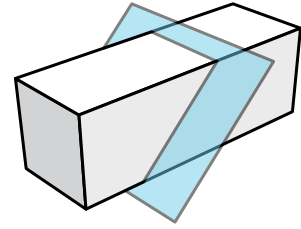

4)

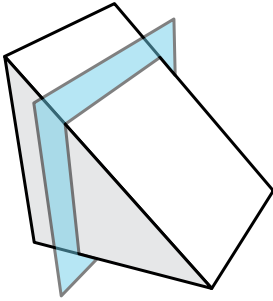

5)

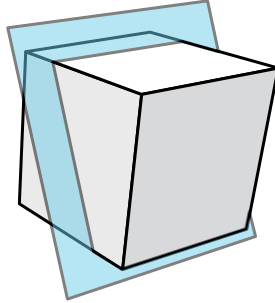

6)

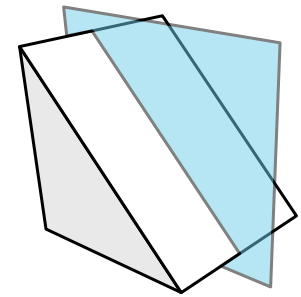

7)

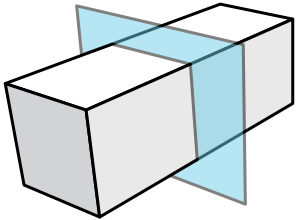

8)

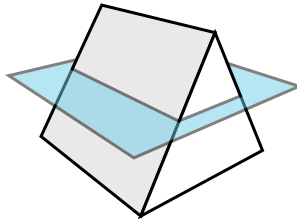

9)

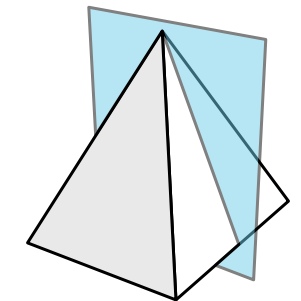



Xác định hình dạng 2d sẽ được tạo ra nếu hình dạng 3d được cắt như hình bên.

1)

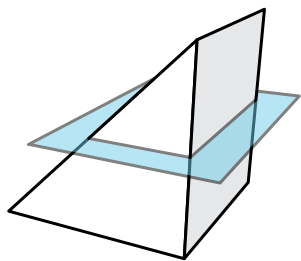

2)

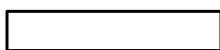
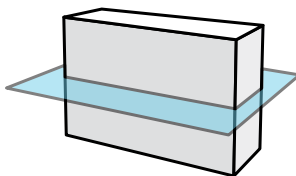

3)

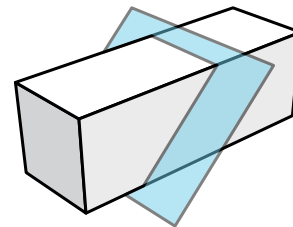

4)

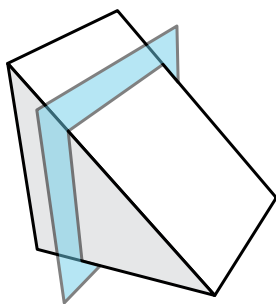

5)

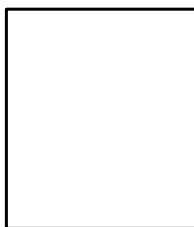
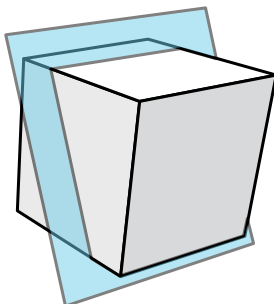

6)

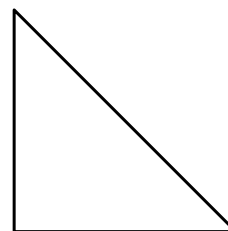
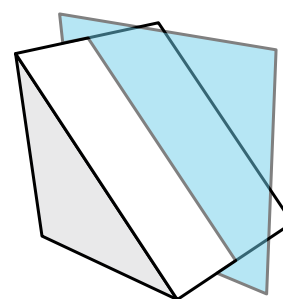

7)

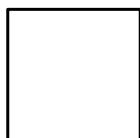
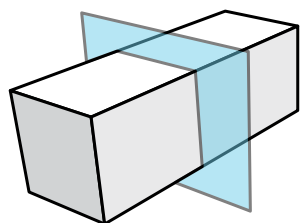

8)

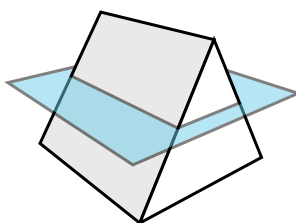

9)

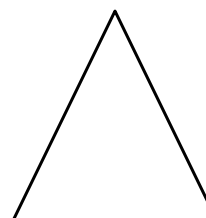
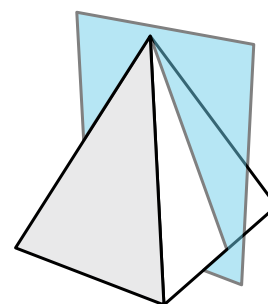



Xác định hình dạng 2d sẽ được tạo ra nếu hình dạng 3d được cắt như hình bên.

1)

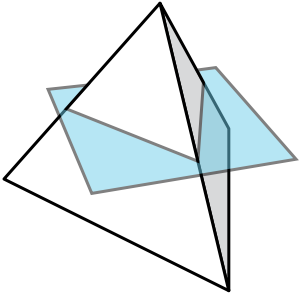

2)

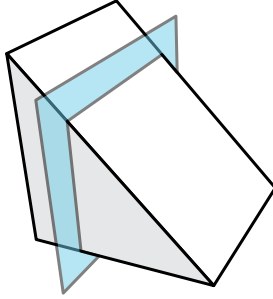

3)

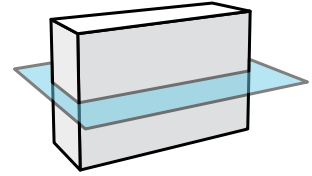

4)

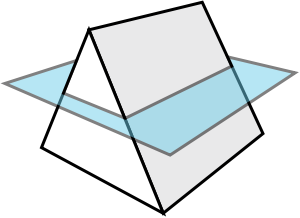

5)

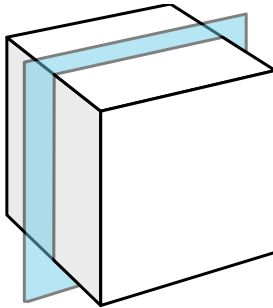

6)

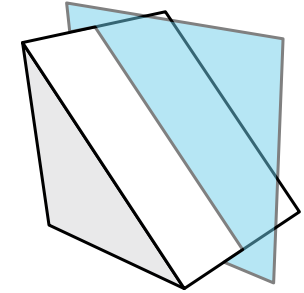

7)

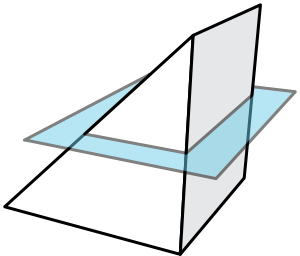

8)

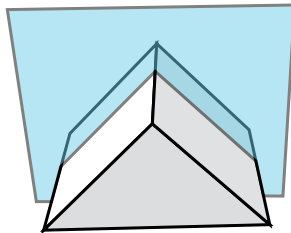

9)

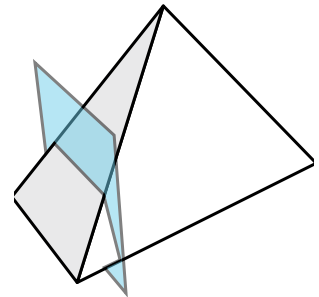



Xác định hình dạng 2d sẽ được tạo ra nếu hình dạng 3d được cắt như hình bên.

1)

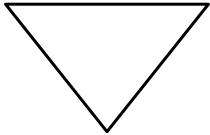
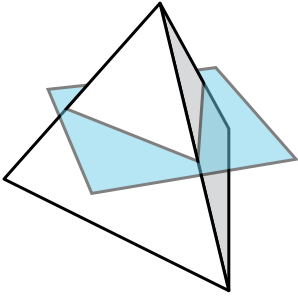

2)

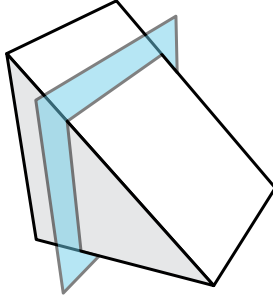

3)

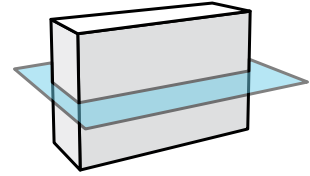

4)

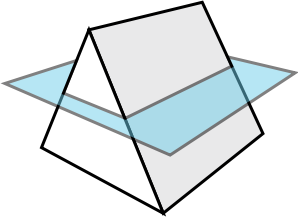

5)

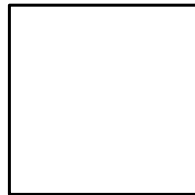
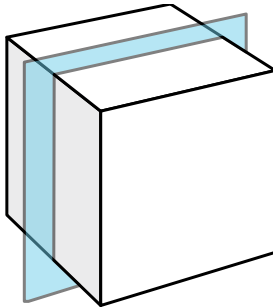

6)

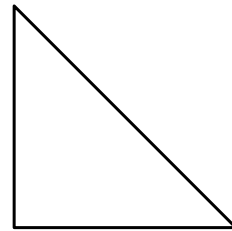
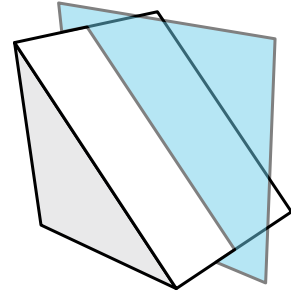

7)

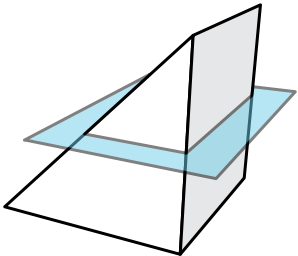

8)

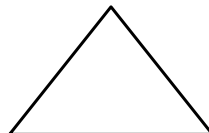
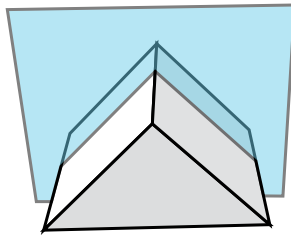

9)

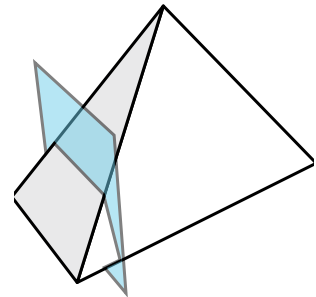



Xác định hình dạng 2d sẽ được tạo ra nếu hình dạng 3d được cắt như hình bên.

1)

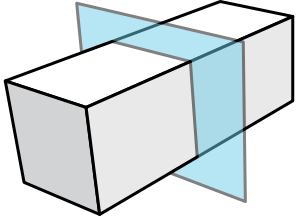

2)

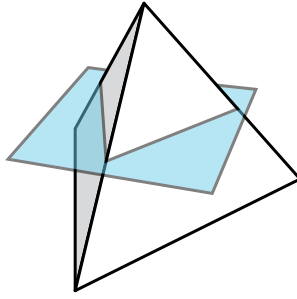

3)

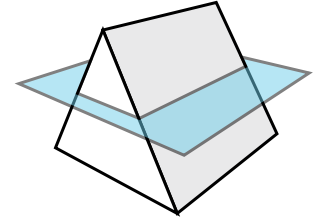

4)

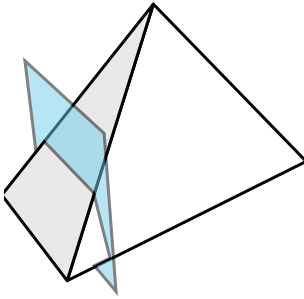

5)

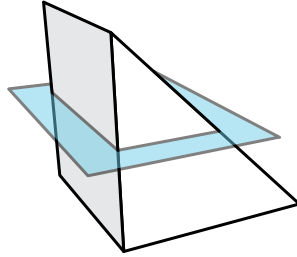

6)

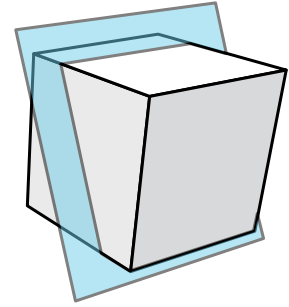

7)

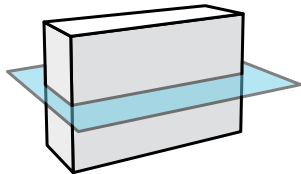

8)

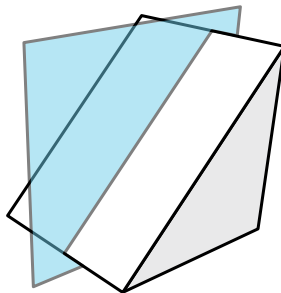

9)

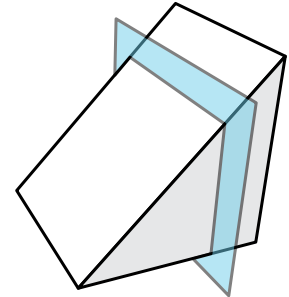



Xác định hình dạng 2d sẽ được tạo ra nếu hình dạng 3d được cắt như hình bên.

1)

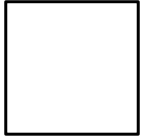
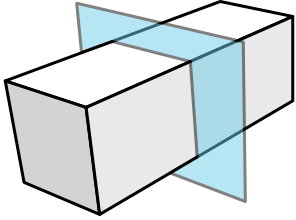

2)

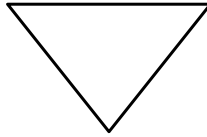
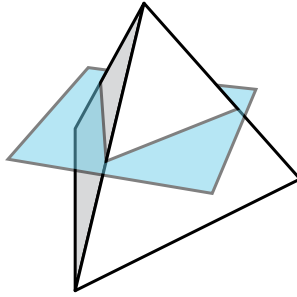

3)

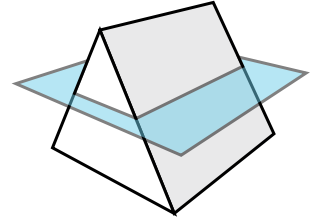

4)

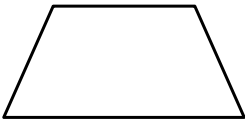
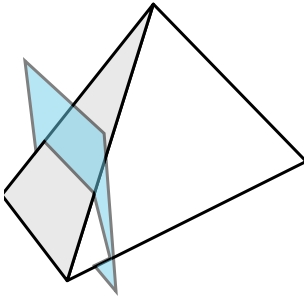

5)

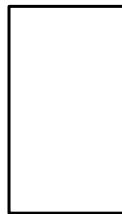
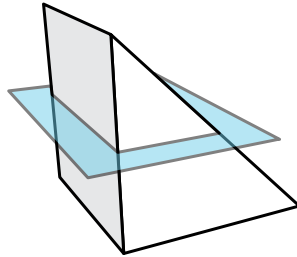

6)

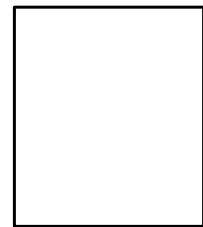
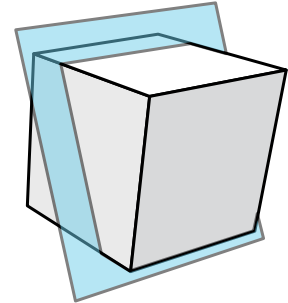

7)

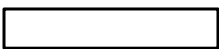
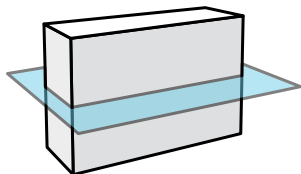

8)

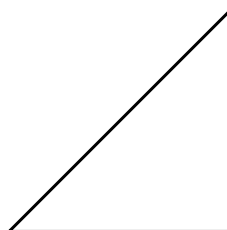
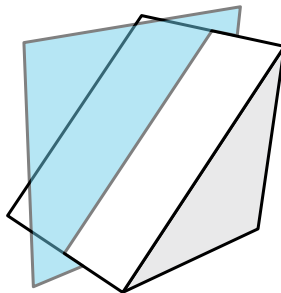

9)

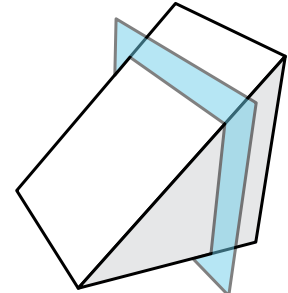





Xác định hình dạng 2d sẽ được tạo ra nếu hình dạng 3d được cắt như hình bên.

1)

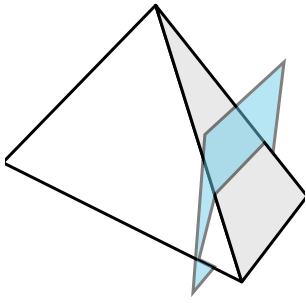

2)

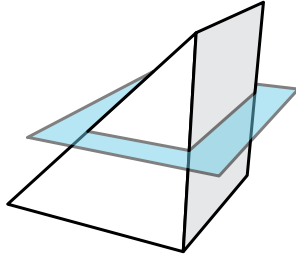

3)

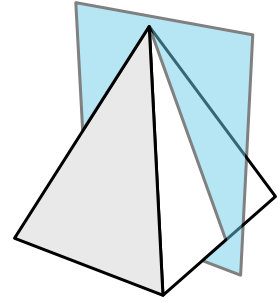

4)

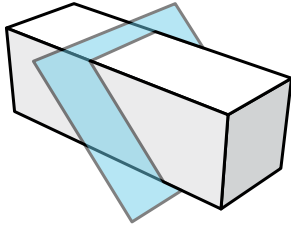

5)

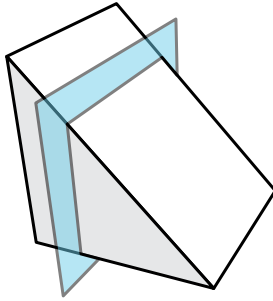

6)

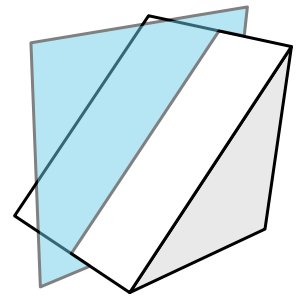

7)

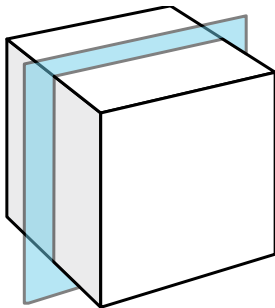

8)

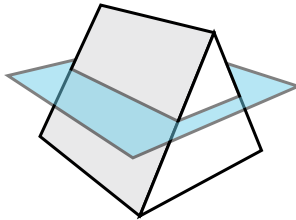

9)

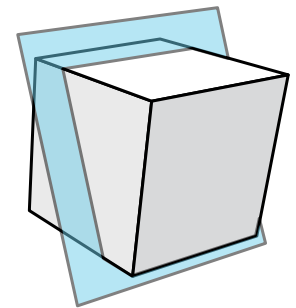



Xác định hình dạng 2d sẽ được tạo ra nếu hình dạng 3d được cắt như hình bên.

1)

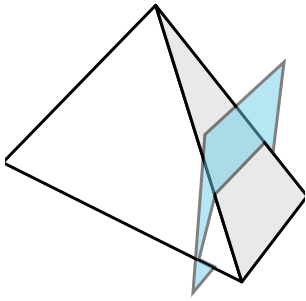

2)

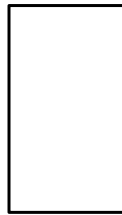
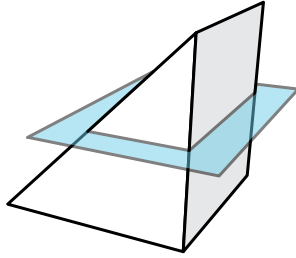

3)

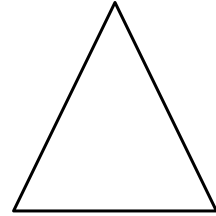
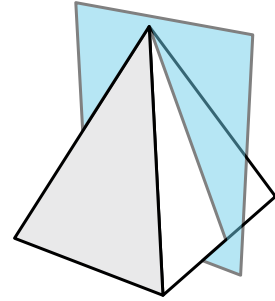

4)

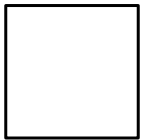
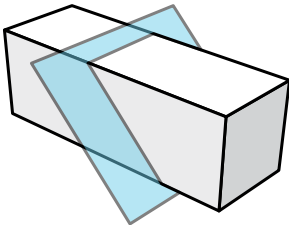

5)

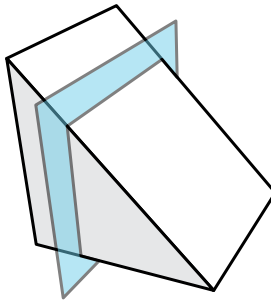

6)

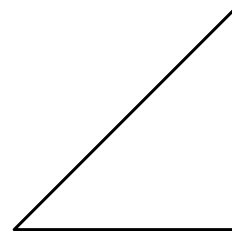
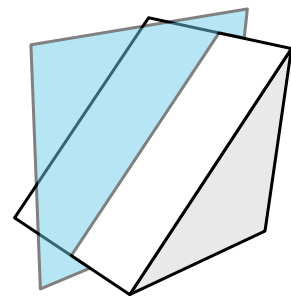

7)

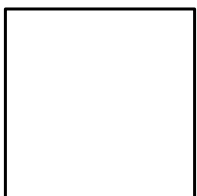
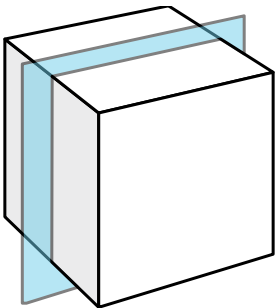

8)

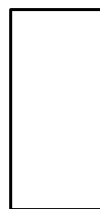
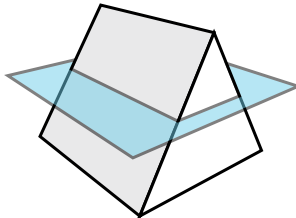

9)

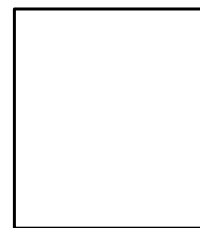
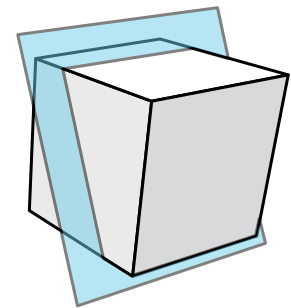



Xác định hình dạng 2d sẽ được tạo ra nếu hình dạng 3d được cắt như hình bên.

1)

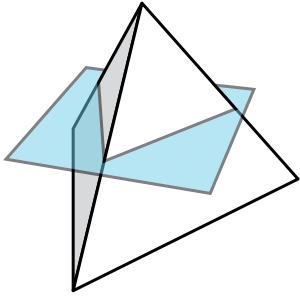

2)

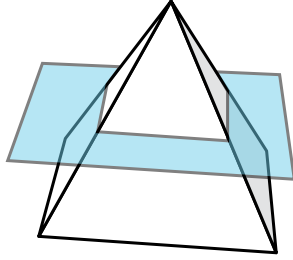

3)

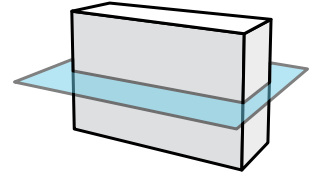

4)

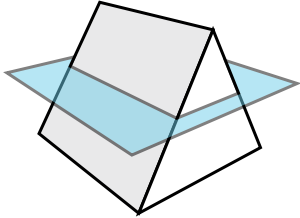

5)

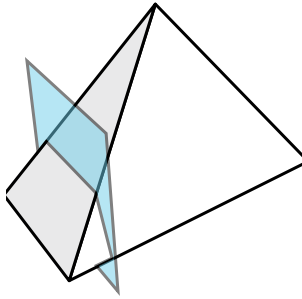

6)

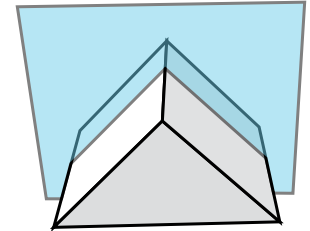

7)

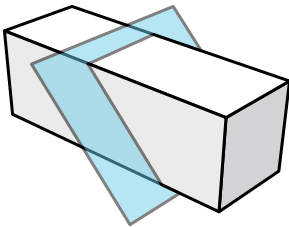

8)

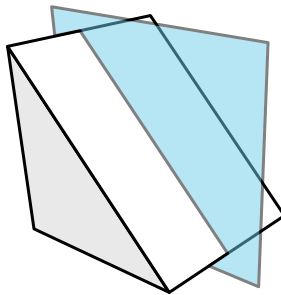

9)

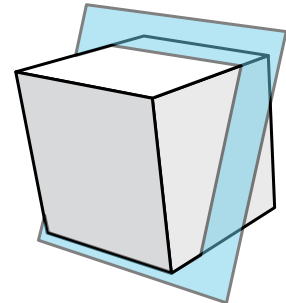



Xác định hình dạng 2d sẽ được tạo ra nếu hình dạng 3d được cắt như hình bên.

1)

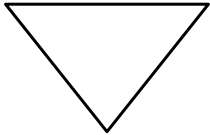
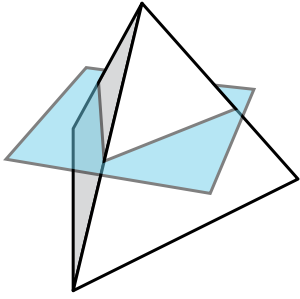

2)

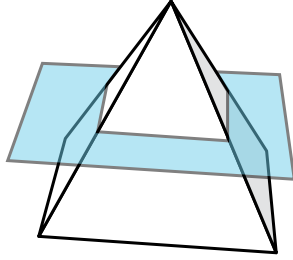

3)

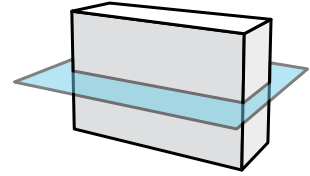

4)

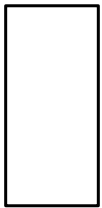
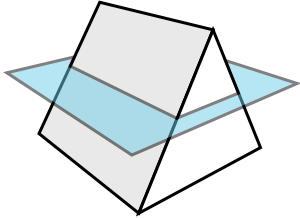

5)

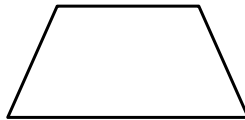
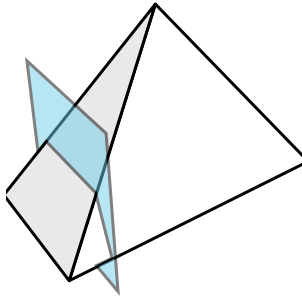

6)

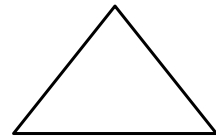
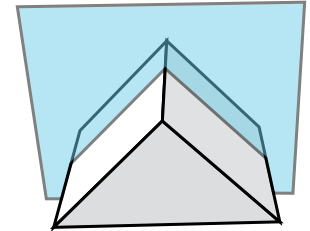

7)

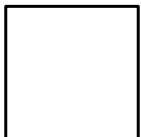
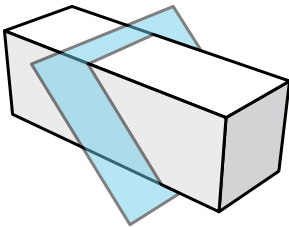

8)

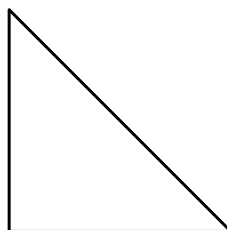
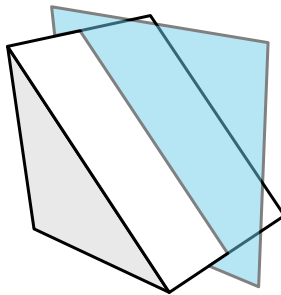

9)

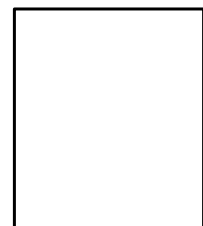
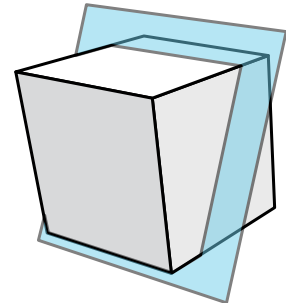



Xác định hình dạng 2d sẽ được tạo ra nếu hình dạng 3d được cắt như hình bên.

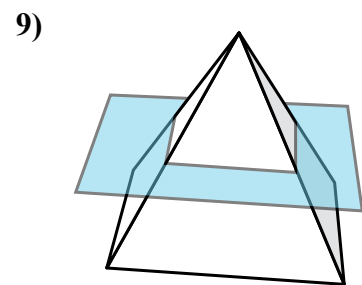
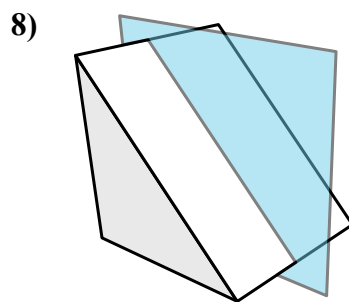
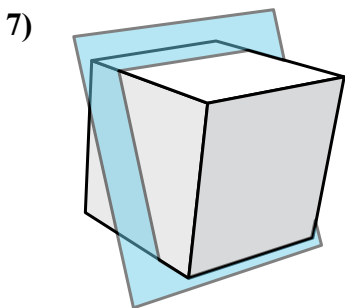
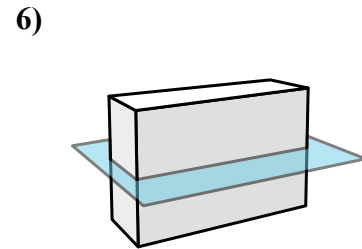
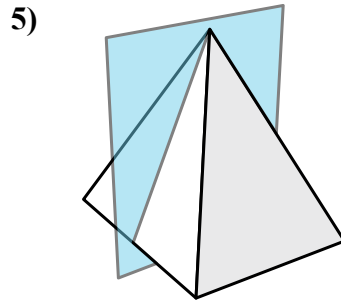
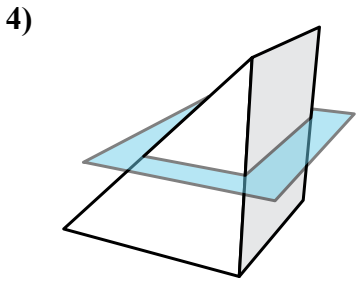
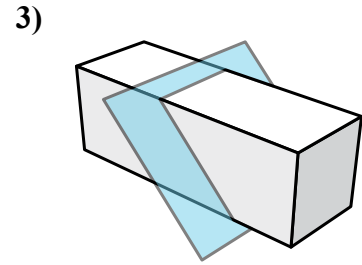
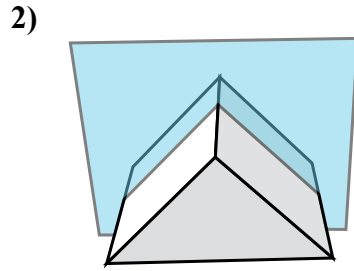
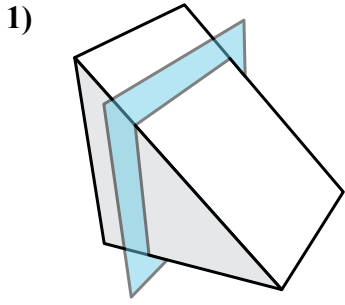



Xác định hình dạng 2d sẽ được tạo ra nếu hình dạng 3d được cắt như hình bên.

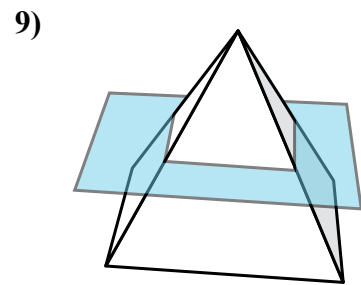
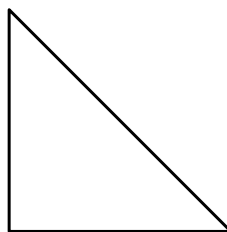
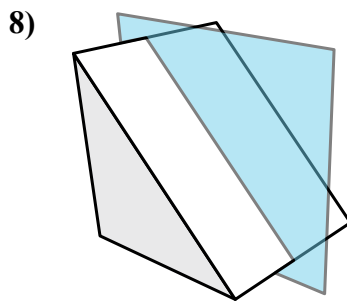
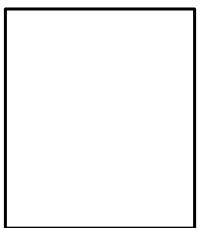
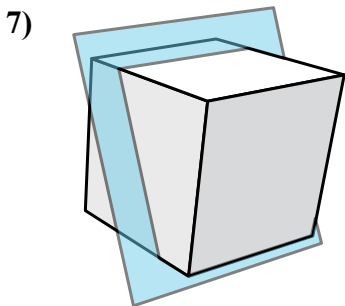
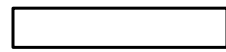
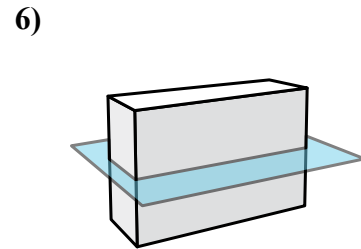
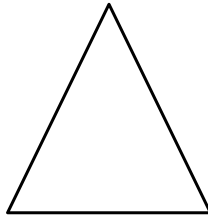
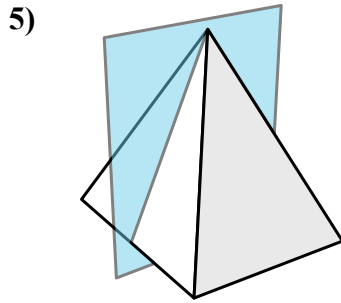
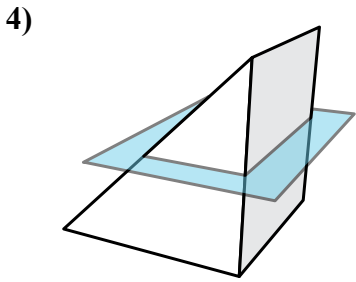
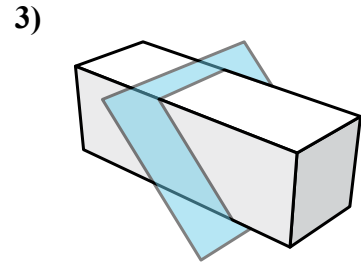
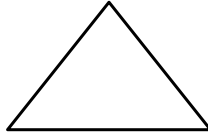
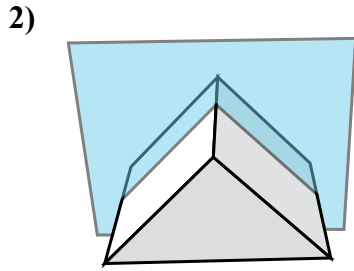
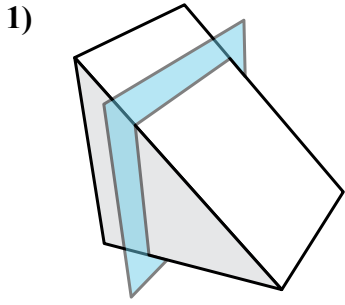



Xác định hình dạng 2d sẽ được tạo ra nếu hình dạng 3d được cắt như hình bên.

1)

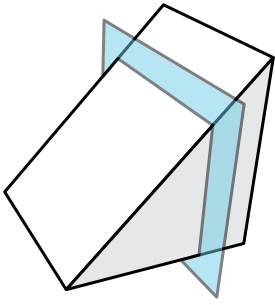

2)

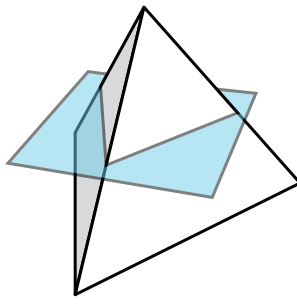

3)

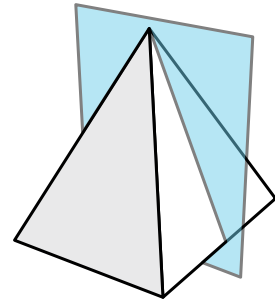

4)

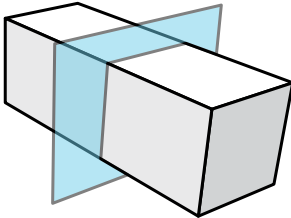

5)

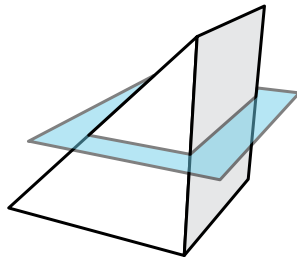

6)

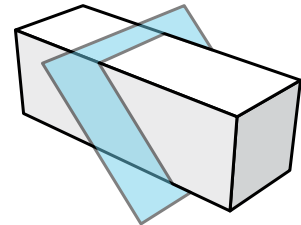

7)

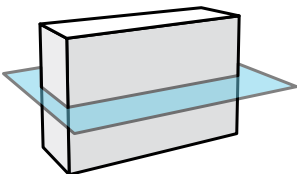

8)

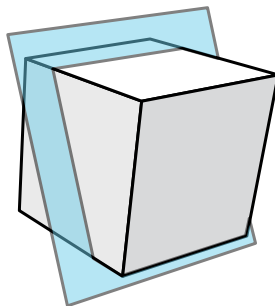

9)

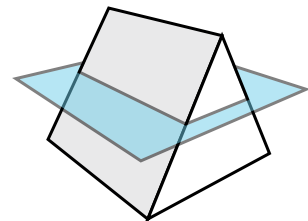



Xác định hình dạng 2d sẽ được tạo ra nếu hình dạng 3d được cắt như hình bên.

1)

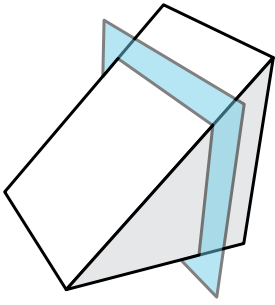

2)

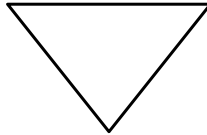
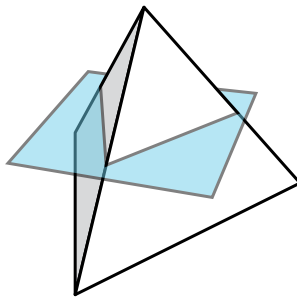

3)

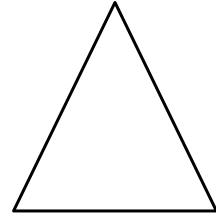
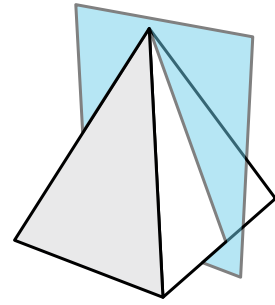

4)

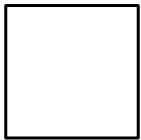
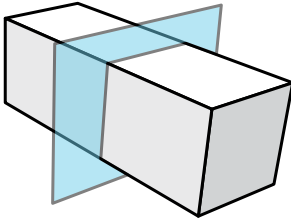

5)

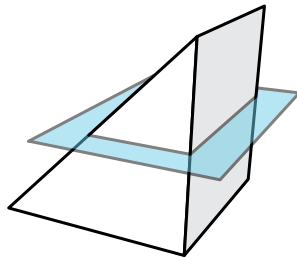

6)

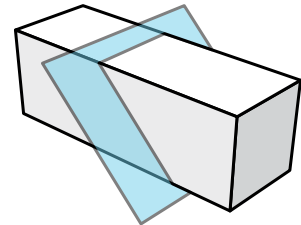

7)

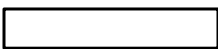
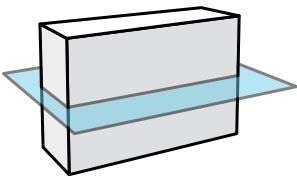

8)

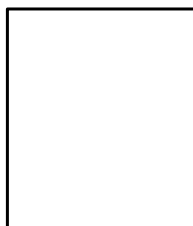
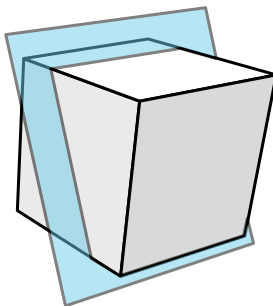

9)

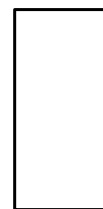
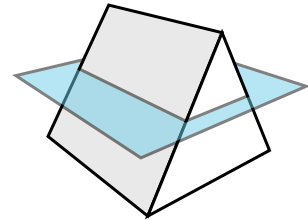





Xác định hình dạng 2d sẽ được tạo ra nếu hình dạng 3d được cắt như hình bên.

1)

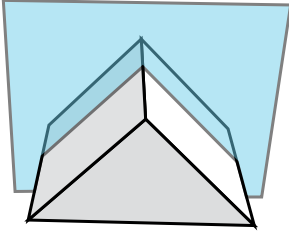

2)

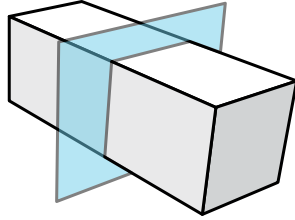

3)

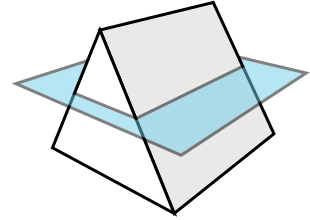

4)

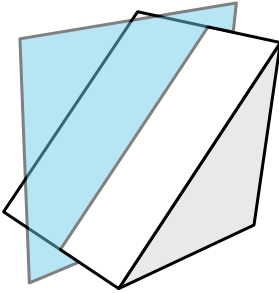

5)

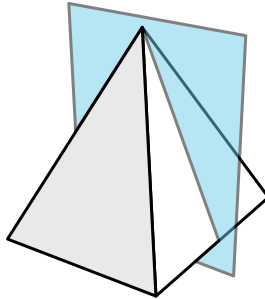

6)

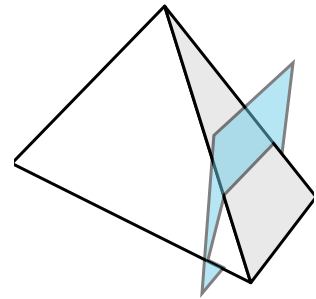

7)

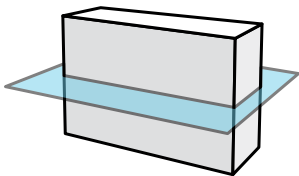

8)

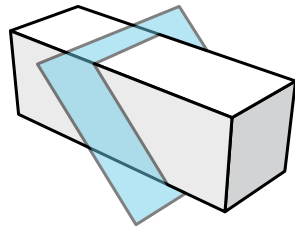

9)

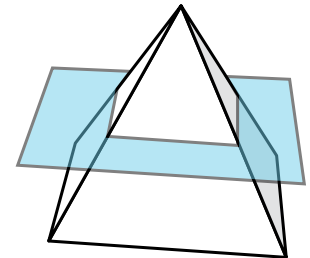



Xác định hình dạng 2d sẽ được tạo ra nếu hình dạng 3d được cắt như hình bên.

1)

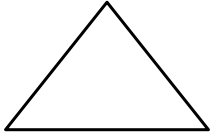
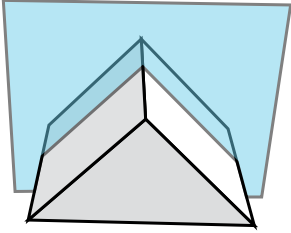

2)

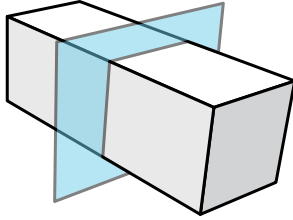

3)

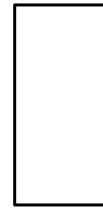
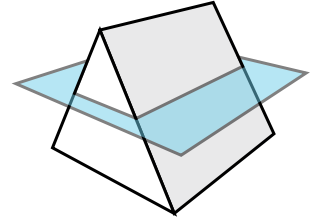

4)

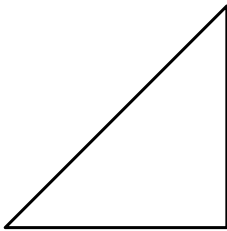
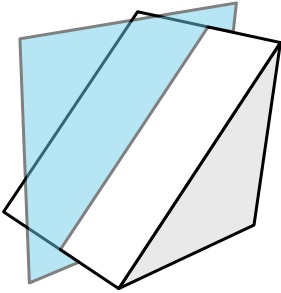

5)

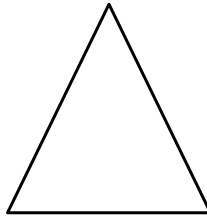
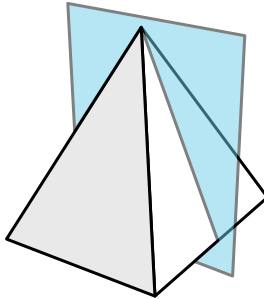

6)

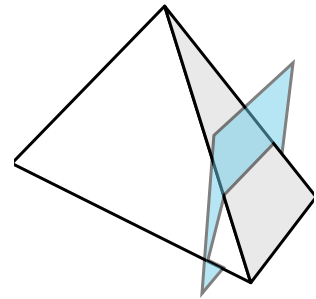

7)

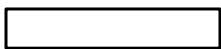
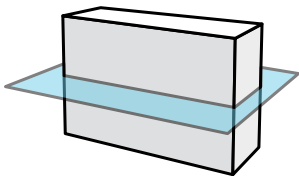

8)

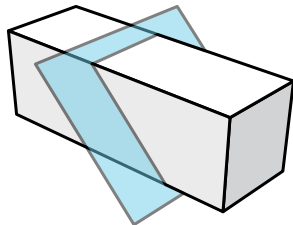

9)

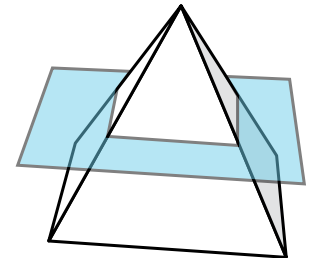



Xác định hình dạng 2d sẽ được tạo ra nếu hình dạng 3d được cắt như hình bên.

1)

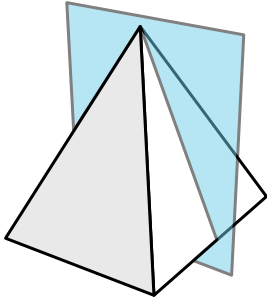

2)

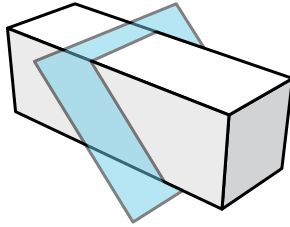

3)

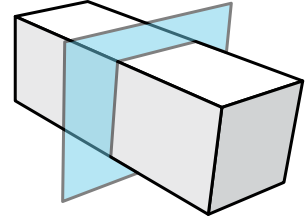

4)

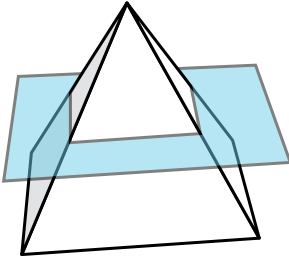

5)

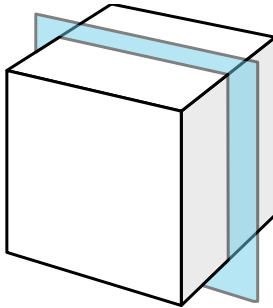

6)

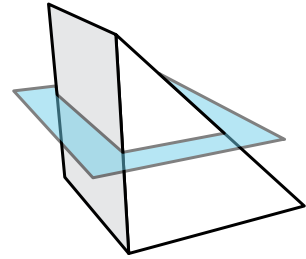

7)

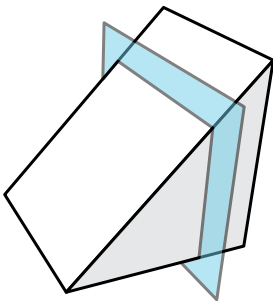

8)

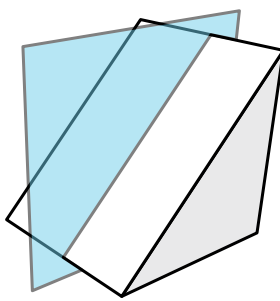

9)

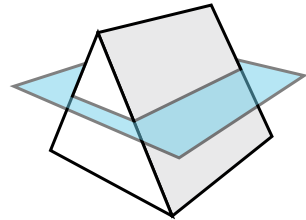



Xác định hình dạng 2d sẽ được tạo ra nếu hình dạng 3d được cắt như hình bên.

1)

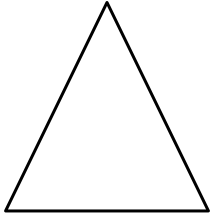
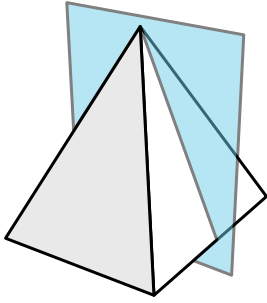

2)

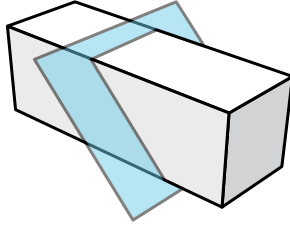

3)

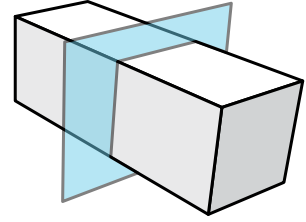

4)

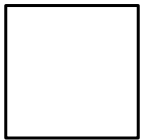
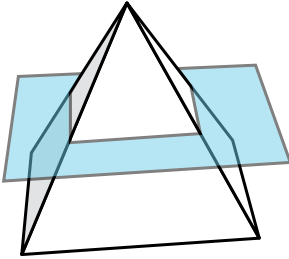

5)

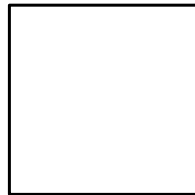
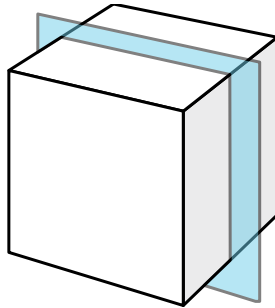

6)

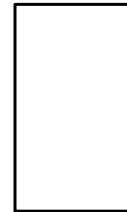
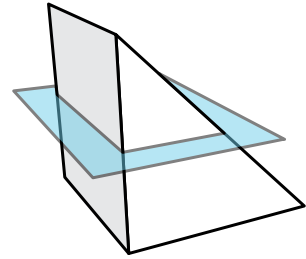

7)

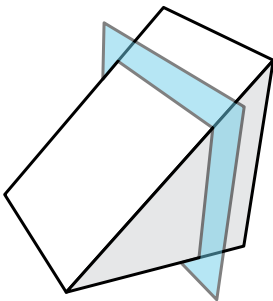

8)

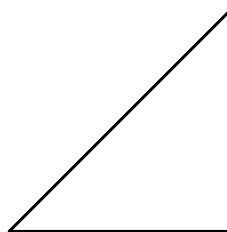
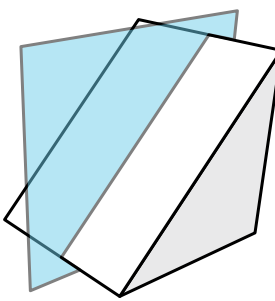

9)

