

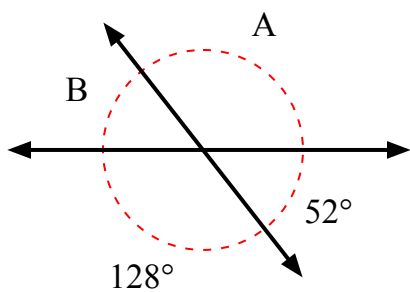

Tìm giá trị của góc 'A' và góc 'B'.

1)



2)

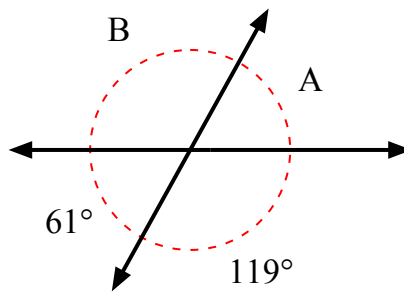

3)

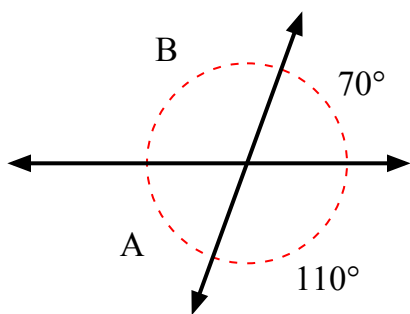

4)

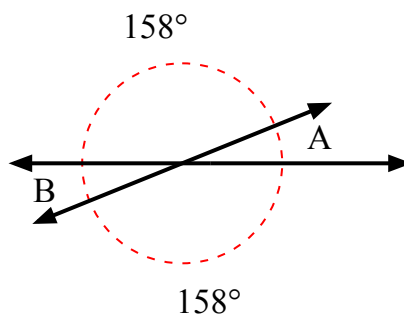

5)

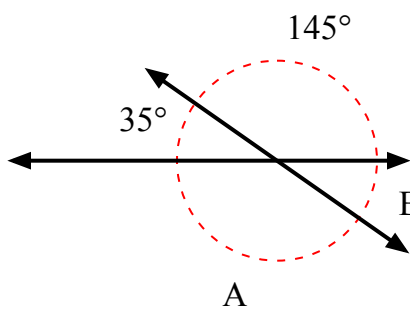

6)

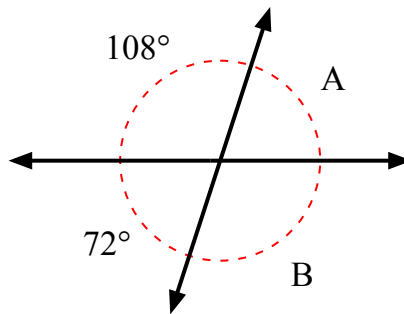

7)

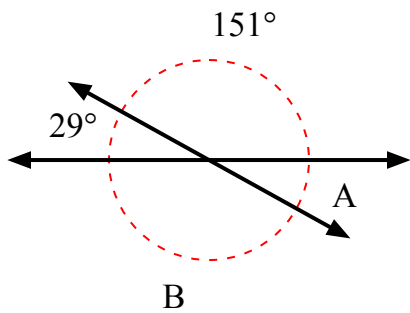

8)

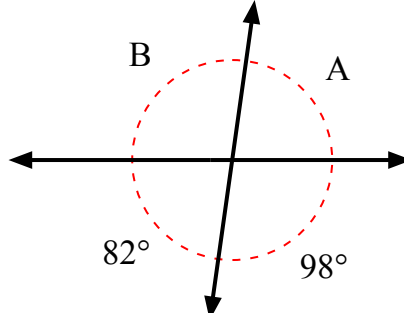

Câu trả lời

1. _____
2. _____
3. _____
4. _____
5. _____
6. _____
7. _____
8. _____



Tìm giá trị của góc 'A' và góc 'B'.

1)

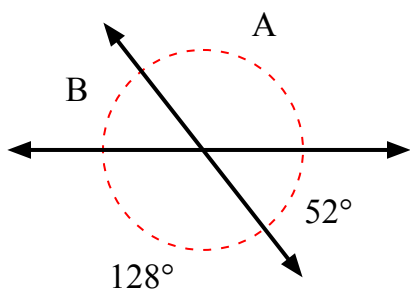

2)

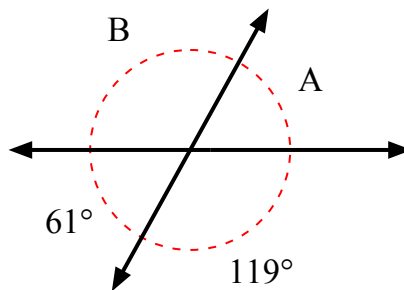

3)

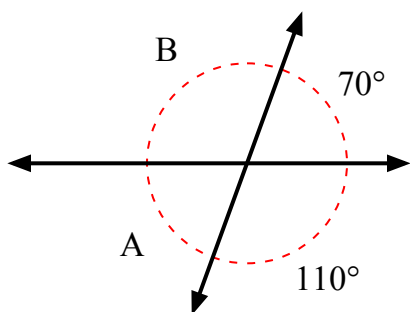

4)

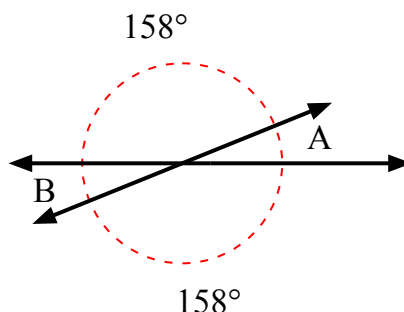

5)

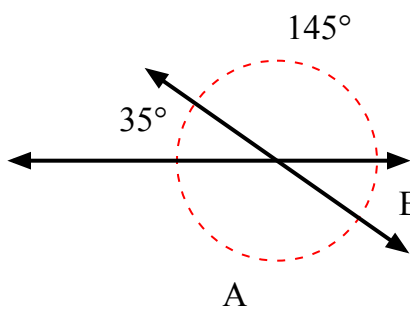

6)

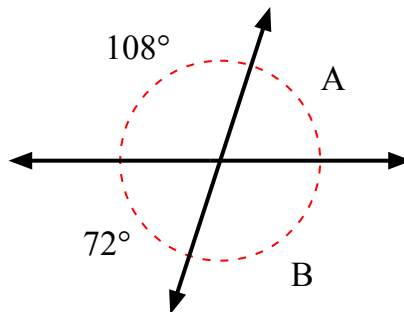

7)

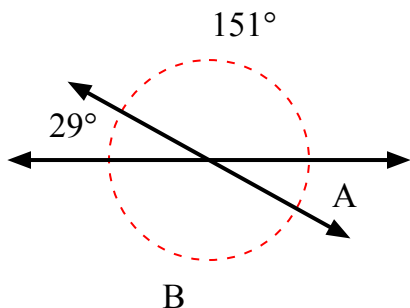

8)

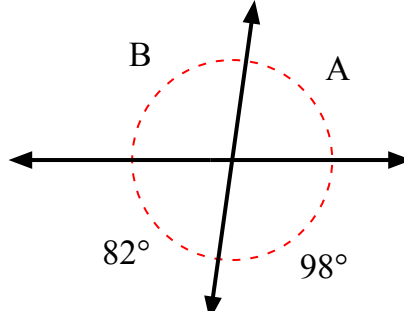

Câu trả lời

1.	128°	52°
2.	61°	119°
3.	70°	110°
4.	22°	22°
5.	145°	35°
6.	72°	108°
7.	29°	151°
8.	82°	98°